

NEWS
2020

TUTTE LE NOVITÀ DEL GRUPPO GAROFOLI ALL GAROFOLI GROUP NEW PRODUCTS

INDICE INDEX

PORTE E SISTEMI DIVISORI DOORS AND DIVIDER SYSTEMS

02

- 04 CATALOGO COLLEZIONI 50
COLLEZIONI 50 CATALOGUE
- 06 COLLEZIONE POEMA
POEMA COLLECTION
- 10 TELAIO FIOMURO UNIVERSALE
FIOMURO UNIVERSAL FRAME
- 12 FIOMURO COVER
FIOMURO COVER
- 14 PORTE FILOSOFITTO
CEILING-HEIGHT DOORS
- 16 MECCANISMI SCORREVOLI
SLIDING MECHANISMS
- 18 NUOVI COLORI PER LE COLLEZIONI REI
NEW COLOURS FOR REI COLLECTIONS
- 20 COLLEZIONE NO-LIMITS RESTYLING
NO-LIMITS RESTYLING COLLECTION
- 22 NUOVO CATALOGO G-LIKE
G-LIKE NEW CATALOGUE
- 24 PARETE SEPARÉ A FISARMONICA
ACCORDION SEPARATOR WALL
- 28 PARETI VETRATE FISSE E CONTINUE
FIXED AND CONTINUOUS GLASS WALLS
- 32 PARETE DIVISORIA ORIENTABILE
SWIVEL PARTITION WALL
- 36 NUOVO CATALOGO MANIGLIE PER PORTE E FINESTRE
DOORS AND WINDOWS NEW HANDLES CATALOGUE

AMBIENTI ROOM

38

- 40 BOISERIE LISCIA A TUTTA ALTEZZA
SMOOTH VERTICAL PANELLING
- 46 BOISERIE CON LISTELLI IN LAMINATO
LAMINATED SLATTED PANELLING
- 50 BOISERIE IN VETRO
GLASS PANELLING
- 58 CABINA UP
UP CABIN
- 62 COLLEZIONE MIRIA SMOOTH IN LEGNO
MIRIA SMOOTH COLLECTION IN WOOD
- 64 MIRIA BASSA CON TOP
LOW MIRIA WITH TOP
- 66 OPEN BOX INDUSTRIAL
OPEN BOX INDUSTRIAL
- 68 MENSOLA A PARETE "LINE"
WALL SHELF "LINE"
- 70 NUOVA LIBRERIA componibile
NEW MODULAR LIBRARY
- 72 PAVIMENTO "LIGHTWOOD"
"LIGHTWOOD" FLOOR
- 74 NUOVO CATALOGO PAVIMENTO SEAWOOD
NEW SEAWOOD FLOOR CATALOGUE
- 76 CUSTOM KITCHEN
CUSTOM KITCHEN
- 78 BOX DOCCIA
SHOWER CABIN
- 82 SPECCHIERE
MIRRORS
- 84 NUOVI TAVOLI IN LEGNO MASSICCIO
NEW SOLID WOOD TABLES
- 92 NUOVI TAVOLI E SEDUTE INDUSTRIAL
NEW INDUSTRIAL TABLES AND SEATING
- 94 SEDUTA "OAK"
"OAK" SITTING
- 96 COLLEZIONE "CERCHI DI LUCE"
"CERCHI DI LUCE" COLLECTION
- 98 COLLEZIONE "LED SQUARE LAMP"
"LED SQUARE LAMP" COLLECTION
- 100 LED WOOD LAMP
LED WOOD LAMP
- 102 LETTO BASE LEGNO E SOMMIER
WOOD BED BASE AND SOMMIER

GAROFOLI
GROUP

GAROFOLI

GIDEA

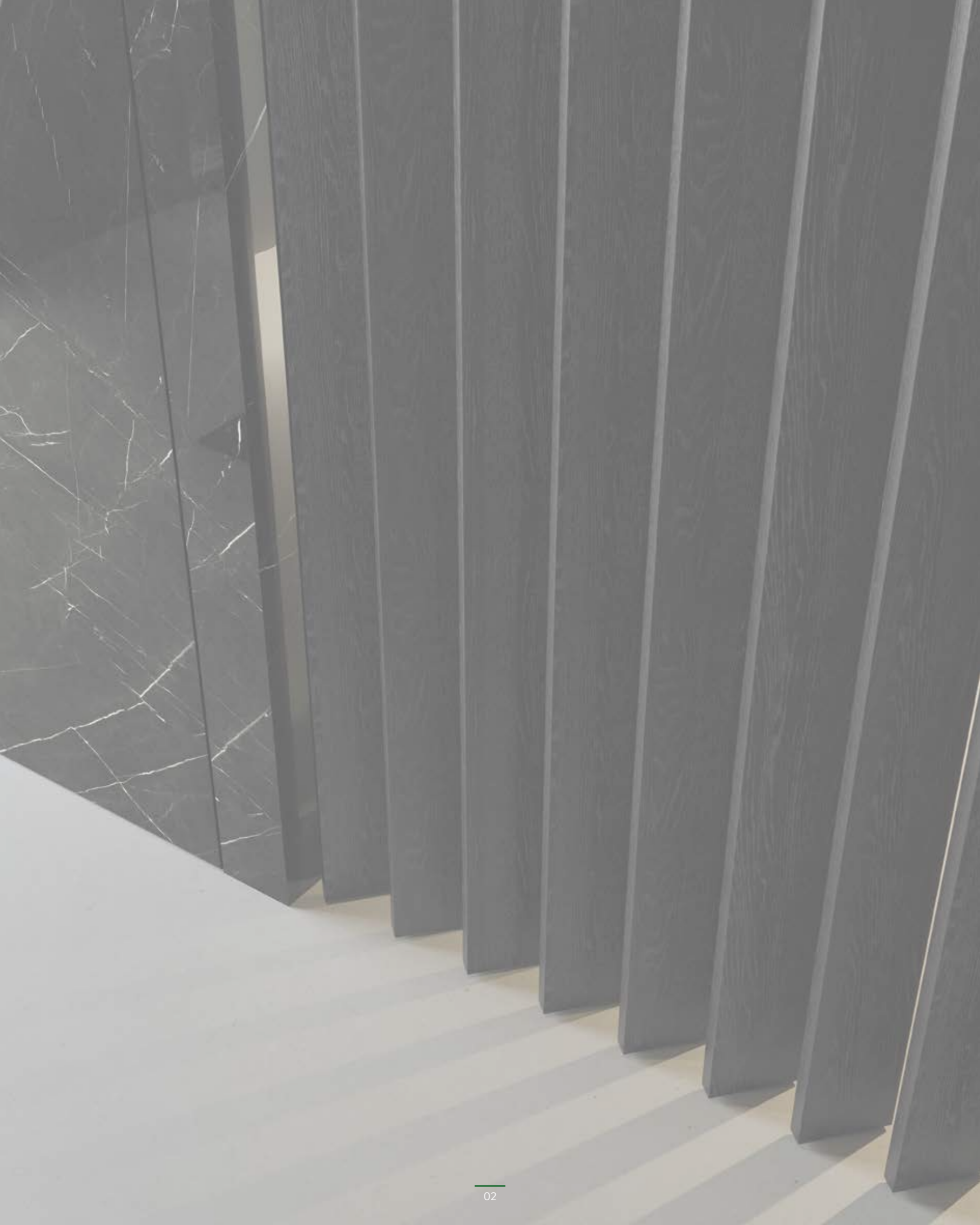

GAROFOLI
GROUP

PORTE E SISTEMI DIVISORI DOORS AND DIVIDER SYSTEMS

CATALOGO COLLEZIONI 50 COLLEZIONI 50 CATALOGUE



Milia, Patio e Spenia sono le nuove collezioni con cui Garofoli si è presentata in fiera a Milano nel 2019. Tutte e tre sono accomunate dalla stessa tipologia di telaio: dal lato a tirare la mostrina è a toppa, complanare all'anta, mentre dall'altro lato a spingere la mostrina può essere scelta in due modalità (a toppa o telescopica). Cerniere a **scomparsa** e serratura **magnetica** completano la dotazione di serie.

Milia, Patio and Spenia are the new collections that Garofoli will be presenting at the trade show in Milan. All three feature the same type of frame: full overlay jambs on the pull side, and two different types of jamb to choose from on the push side (full overlay or telescopic). **Concealed** hinges and **magnetic** latches complete the standard configuration.

Collezioni 50, porta battente Spenia modello Site 1V, finitura Rovere Laccato Bianco a poro aperto, Vetro Madras, lato a spingere.

50 Collections, Spenia swing door, Site 1V model, open-pore White Lacquered Oak finish, Madras Glass, push side.



Consulta il catalogo Collezioni 50.
See the Collezioni 50 catalogue.



Collezione Poema porta battente, finitura Laccato Tortora, pantografatura Pimoto, lato a spingere.

Poema collection swing door, Light Grey Lacquer finish, Pimoto routing, push side.

COLLEZIONE POEMA POEMA COLLECTION

COLLEZIONE POEMA | POEMA COLLECTION
SEZIONE ORIZZONTALE | HORIZONTAL CROSS-SECTION

LATO A TIRARE | PULL SIDE

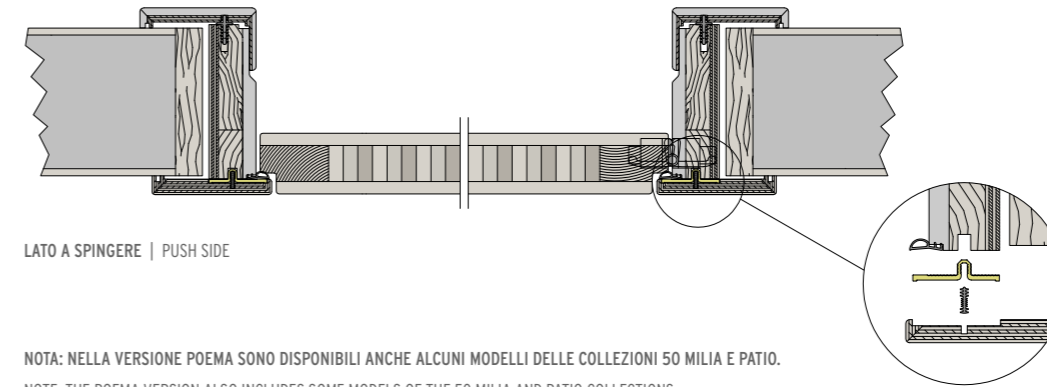

LATO A SPINGERE | PUSH SIDE

NOTA: NELLA VERSIONE POEMA SONO DISPONIBILI ANCHE ALCUNI MODELLI DELLE COLLEZIONI 50 MILIA E PATIO.
NOTE: THE POEMA VERSION ALSO INCLUDES SOME MODELS OF THE 50 MILIA AND PATIO COLLECTIONS.

LATO A TIRARE | PULL SIDE

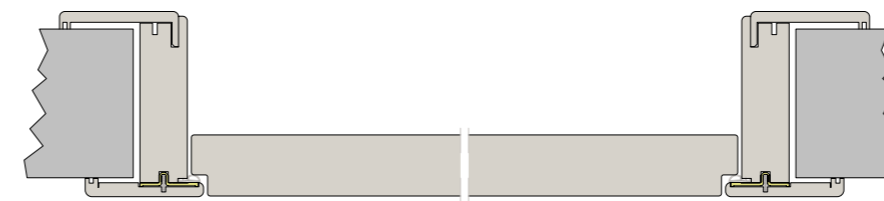

LATO A SPINGERE | PUSH SIDE

**NUOVE PANTOGRAFATURE
DISPONIBILI:
NEW AVAILABLE ROUTING:**

**MILIA
PATIO
MIRAQUADRA
MIRABILIA**

Con Poema la porta liscia o liscia con inserti metallici e qualsiasi modello delle collezioni

- Mirabilia
- Miraquadra;
- Milia;
- Patio,

può essere interpretato nella versione complanare a spingere, cioè con mostrine e anta sullo stesso piano lato a spingere.

With Poema the door is smooth or smooth with metal inserts, and any model from the collections

- Mirabilia
- Miraquadra
- Milia
- Patio

can be interpreted in the coplanar push version, i.e. with flush jambs and door on the push side.



Collezione Poema porta battente, finitura Laccato Tortora, pantografatura Pimoto, lato a spingere a sinistra, lato a tirare a destra.

Poema collection swing door, Light Grey Lacquer finish, Pimoto routing, left push side, right pull side.

TELAIO FILOMURO UNIVERSALE

FILOMURO UNIVERSAL FRAME



Sezione del telaio Filomuro orizzontale
Cross-section of the horizontal Filomuro frame

SEZIONE ORIZZONTALE | HORIZONTAL CROSS-SECTION

LATO A TIRARE | PULL SIDE

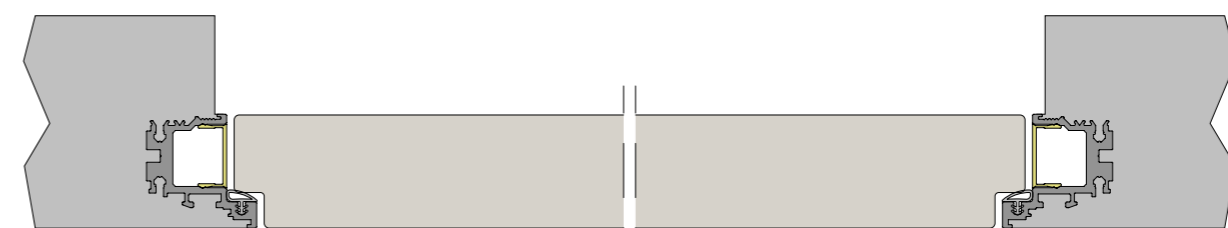

LATO A SPINGERE | PUSH SIDE

Il telaio filomuro universale si presta ad essere utilizzato nelle situazioni meno programmabili. Il telaio viene definito generico e universale perchè è possibile decidere al momento della messa in opera quale sarà verso e la tipologia dell'anta: non è vincolato dal numero e dalla tipologia delle cerniere.

The universal Filomuro frame can be used in the most unpredictable situations. The frame is considered to be generic and universal because it's possible to decide the direction and the type of door at the time of installation. It's not bound by the number or type of hinges.

FILOMURO COVER

FILOMURO COVER



Modello Cover. Parete e porta rivestiti con gres porcellanato (spessore max. 5 mm)
Cover model. Wall and door covered with porcelain stoneware tiles (max thickness 5 mm)

SEZIONE ORIZZONTALE | HORIZONTAL CROSS-SECTION

LATO A SPINGERE | PUSH SIDE

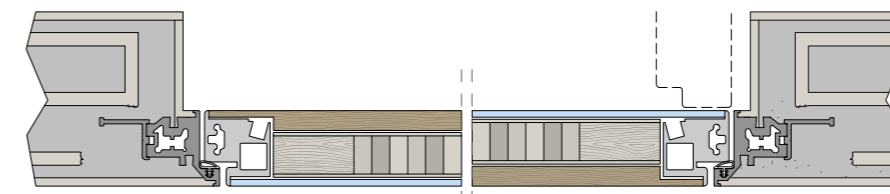

LATO A TIRARE | PULL SIDE

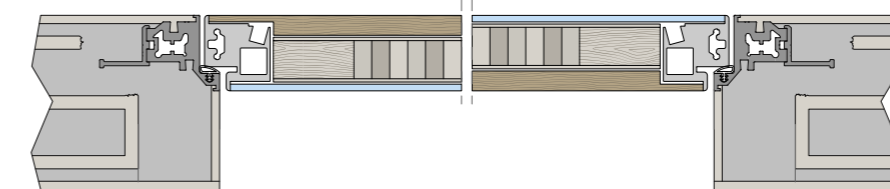

Il modello Filomuro Cover permette di realizzare l'anta con il parquet Garofoli di spessore 12 mm.
La soluzione Cover consente la continuità di materiali tra parete e porta Filomuro versione a spingere, anche utilizzando rivestimenti in gres porcellanato.

The Filomuro Cover model allows creating a door with Garofoli parquet having a 12 mm thickness.
The Cover solution allows for the continuity of materials between the wall and the Filomuro door, push version, even using porcelain stoneware tiles.



Collezioni 50, porta battente Milia modello Mitre 3B, finitura Laccato RAL 6028, lato a spingere. Battiscopa e parquet Platinum Rovere Nero Profondo.

50 Collections, Milia swing door, Mitre 3B model, RAL 6028 Lacquer finish, push side. Dark Black Platinum Oak skirting boards and parquet.

PORTE FILOSOFFITTO CEILING-HEIGHT DOORS

Porta con mostrina superiore
Door with top jamb

Porta a filo soffitto senza mostrina superiore
Ceiling-height door without top jamb

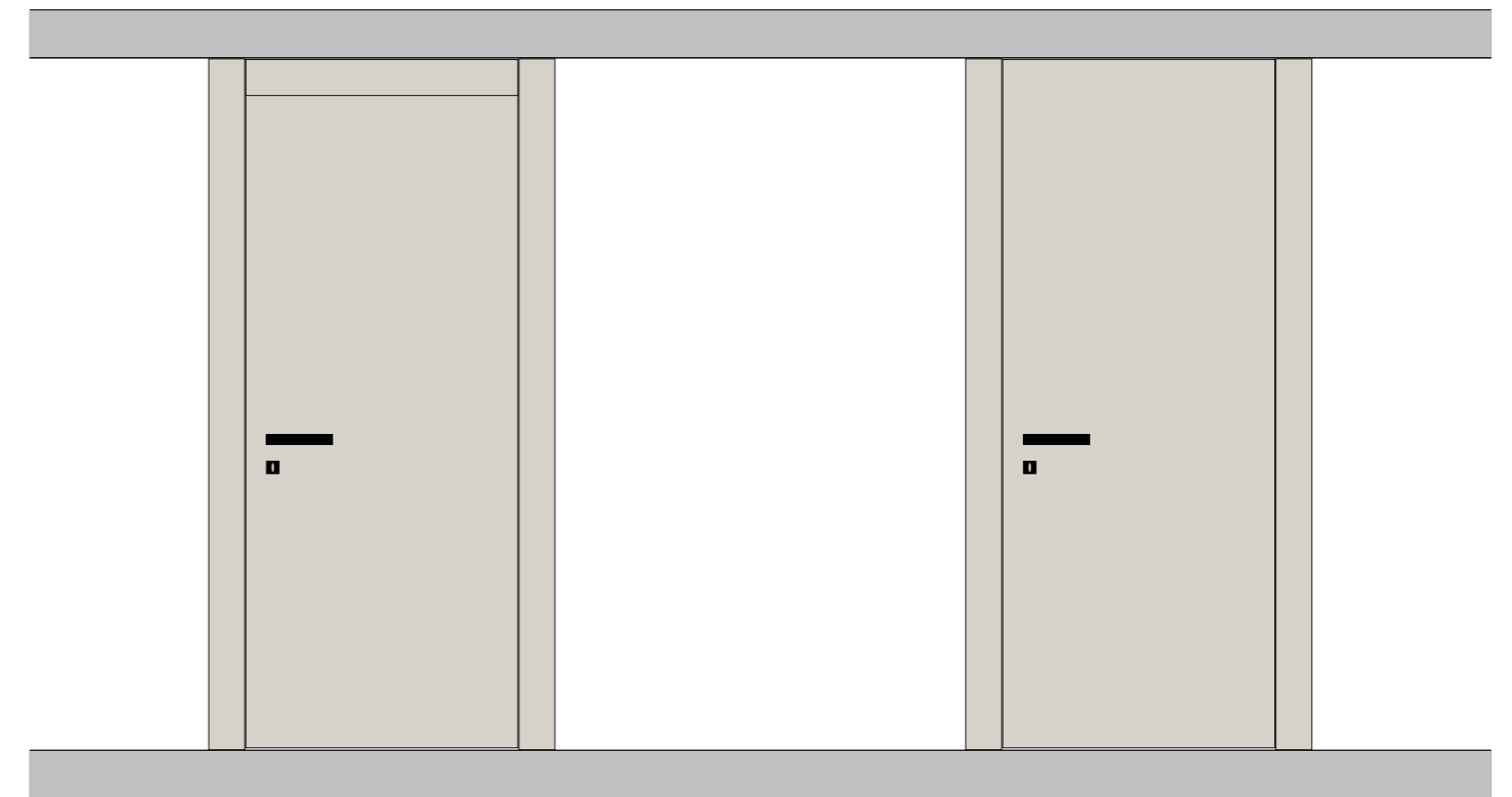

Qualsiasi modello di porte Garofoli può avere la sua versione filo-soffitto, con l'anta che sfiora il soffitto e non batte su alcun telaio superiore.

Any Garofoli door model can be produced in a ceiling-height version, with the door flush with the ceiling and without any upper frame.

MECCANISMI SCORREVOLI

SLIDING MECHANISMS



Porta scorrevole con binario Roller.
Sliding door with Roller track.

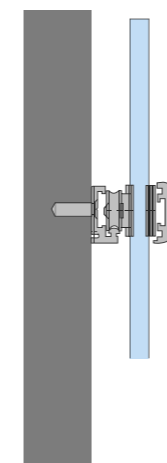

Binario BATIK
BATIK track

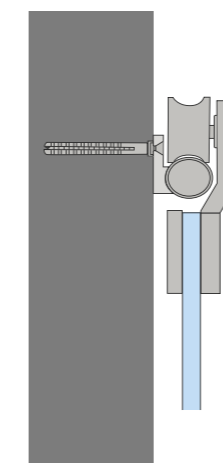

Binario TRIO
TRIO track

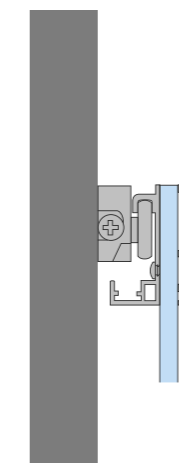

Binario ROLLER
ROLLER track

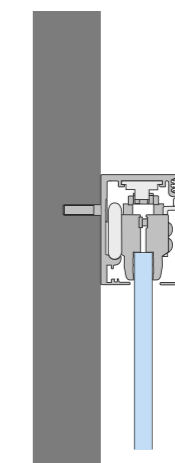

Binario NANO
NANO track

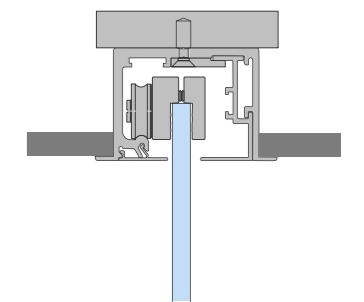

Binario FILOMURO WALL
FILOMURO WALL track

Cinque nuovi binari in metallo garantiscono miglioramenti funzionali ed estetici per tutte le ante a vetro scorrevoli.

Five new metal tracks guarantee functional and aesthetic improvements for all our sliding glass doors.



Consulta il sito web Garofoli.
See the Garofoli web site.

NUOVI COLORI PER LE COLLEZIONI REI

NEW COLOURS FOR REI COLLECTIONS



Collezione Stilia Rei 30 porta a battente resistente al fuoco, nuova finitura Olmo Grigio, modello "liscia", lato a spingere.
Stilia Collection Rei 30 fire-resistant swing door, new Grey Elm finish, smooth model, push side.

Le collezioni REI del Gruppo Garofoli si arricchiscono di nuove finiture in laminato:

- _ LAMINATI OLMO (3 finiture)
- _ LAMINATI QUERCIA
- _ LAMINATI MALTA
- _ LAMINATI BIANCO TEXTURE

Questi laminati sono già disponibili per le collezioni:

- _ STILIA REI 30
- _ POEMA REI 30
- _ GOLD REI 60

The REI collections of the Garofoli Group now include new laminate finishes:

- _ ELM LAMINATE (3 finishes)
- _ OAK LAMINATE
- _ CEMENT LAMINATE
- _ WHITE TEXTURED LAMINATE

These laminates are already available for the collections:

- _ STILIA REI 30
- _ POEMA REI 30
- _ GOLD REI 60



Consulta il catalogo Porte REI.
See the Porte REI catalogue.

COLLEZIONE NO-LIMITS_RESTYLING NO-LIMITS_RESTYLING COLLECTION

Malta su telaio e mostrine
Cement on frame and jambs



Restiling del telaio
Restyling of the frame

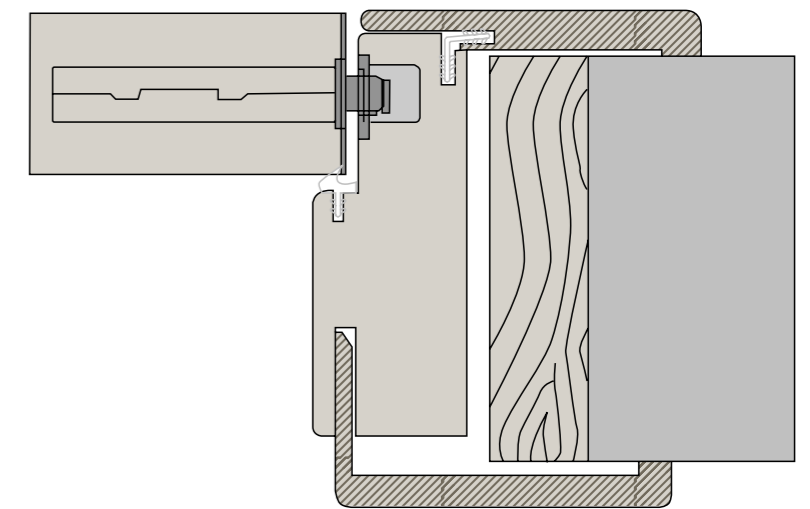

Due importanti cambiamenti per il restyling della collezione No-Limits:

- 1_ Il telaio e le mostrine sono ordinabili nelle stesse finiture dei laminati Malta;
- 2_ Il telaio verrà consegnato assemblato. Inoltre la posizione della mostrina sul telaio è cambiata, riducendo la porzione del telaio a vista, per alleggerire l'impatto estetico della porta nel lato a spingere;
- 3_ Il telaio è costruito totalmente in listellare di legno.

Two important changes for the restyling of the No-Limits collection:

- 1_ The frame and the jambs can be ordered in the same finishes as the Cement laminates;
- 2_ The frame will be delivered already assembled. Furthermore, the position of the jamb on the frame has changed, reducing the portion of the visible frame to lighten the aesthetic impact of the door on the push side.
- 3_ The frame is built entirely of blockboard.



Consulta il catalogo No-Limits.
See the No-Limits catalogue.

NUOVO CATALOGO G-LIKE

NEW G-LIKE CATALOGUE



Collezione G-Like modello Horizon 1VH, finitura Nero, Vetro Trasparente.
Parquet Platinum Garofoli, Rovere Laccato Bianco, boiserie verticale Rovere Nero Profondo.

G-Like collection, Horizon 1VH model, Black finish, Transparent Glass.
Garofoli Platinum parquet, White Lacquered Oak, Dark Black Oak vertical panelling.



CROSS

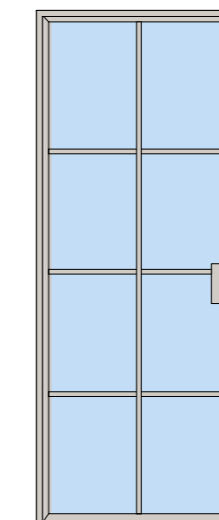

LINE

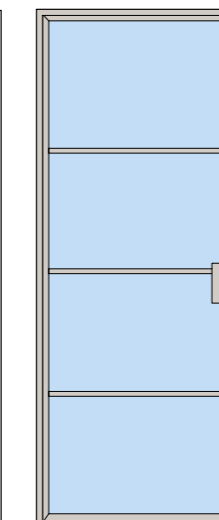

VERT

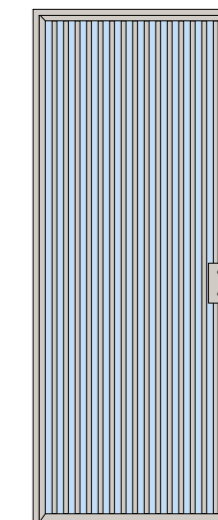

HORIZON

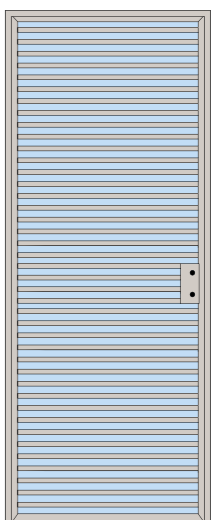

La collezione G-Like si arricchisce di una linea di modelli dal sapore industrial:

- _ CROSS
- _ LINE
- _ HORIZON
- _ VERT

Geometrie che richiamano le classiche strutture a vetro delle fabbriche di un tempo, i nuovi modelli sono disponibili in colori e rivestimenti di grande effetto evocativo.

The G-Like collection now includes a line of models with an industrial flavour:

- _ CROSS
- _ LINE
- _ HORIZON
- _ VERT

With shapes that recall the classic glass structures of the past, the new models are available with colours and coatings that create an evocative effect.



Consulta il nuovo catalogo G-Like.
See the new G-Like catalogue.

PARETE SEPARÉ A FISARMONICA

ACCORDION SEPARATOR WALL



Doppia parete separé a due ante e mezzo + 3 ante e mezzo in Rovere Nero profondo.
Parquet Platinum Selection Rovere Ice.
Tavolo Ellipse Garofoli Rovere Nero.

Double wall partition with two and a half doors + three and a half doors in Dark Black Oak.
Ice Oak Platinum Selection parquet.
Black Oak Garofoli Ellipse table.

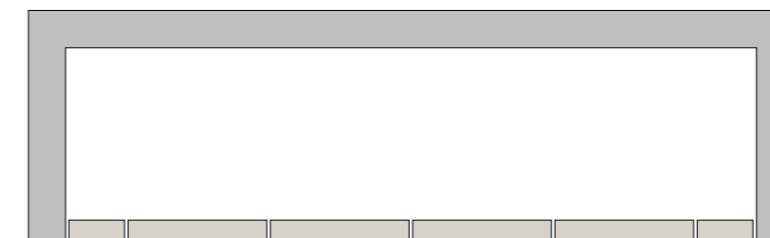

La parete separé a fisarmonica Garofoli risponde principalmente a finalità estetiche: le ante, aventi lo spessore di una porta, possono infatti arrivare fino a soffitto riuscendo a nascondere totalmente vani anche di grandi dimensioni, in continuità con le pareti adiacenti. Il meccanismo di chiusura “a fisarmonica” garantisce il minimo spazio di apertura, consentendo di accostare le ante metà dentro e metà fuori dal vano.

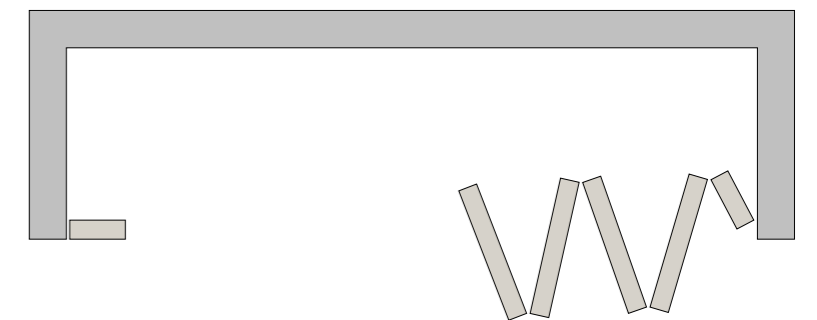

The Garofoli accordion partition wall serves mainly aesthetic purposes. It has the thickness of a door and can reach up to the ceiling, managing to completely hide even large sections flush with the adjacent walls. The accordion closing mechanism guarantees a minimum opening space, the doors stacking half inside and half outside the compartment.



Doppia parete separè in Rovere Nero Profondo.
Parquet Platinum Selection Rovere Ice e tavolo Ellipse Garofoli.
Elementi della cucina in Rovere Ice coordinati col parquet.

Dark Black Oak double wall partition.
Ice Oak Platinum Selection parquet and Ellipse Garofoli table.
Ice Oak kitchen elements coordinated with the parquet.

PARETI VETRATE FISSE E CONTINUE

FIXED AND CONTINUOUS GLASS WALLS



Porta tuttovetro 1TV con cerniere pivotanti nere.
Pareti fisse in vetro con profili di bloccaggio superiore e inferiore neri.

1TV all-glass door with black pivoting hinges.
Fixed glass walls with black upper and lower locking strips.

Soluzione con porta 1TV a bilico apribile
Solution with pivoting 1TV door

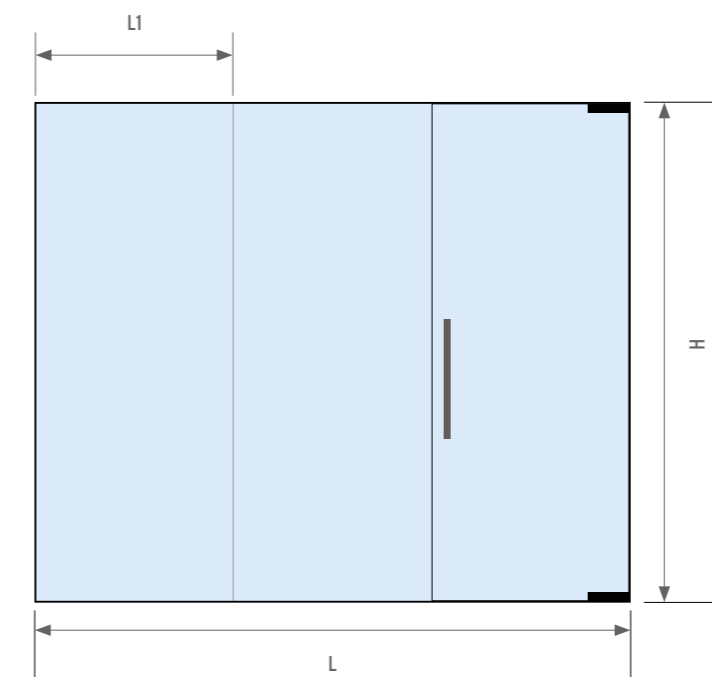

I Vetri del Gruppo Garofoli possono comporre anche sistemi vetrati “tutto-vetro”, caratterizzati da ante vetrate fisse a tutta altezza e da Porte 1TV (scorrevoli o a battente) accostate tra loro, adatti per dividere la zona lavoro o per creare spazi acusticamente isolati, ma in continuità visiva con l’ambiente circostante. I vetri a tutta altezza sono separati uno dall’altro solo da una piccola guarnizione siliconica trasparente: questo tipo di assemblaggio consente la realizzazione di angoli tuttovetro che non necessitano di alcun telaio strutturale.



Consulta il catalogo Emozioni di vetro.
See the Emozioni di vetro catalogue.

Soluzione con porta 1TV scorrevole
Solution with sliding 1TV door

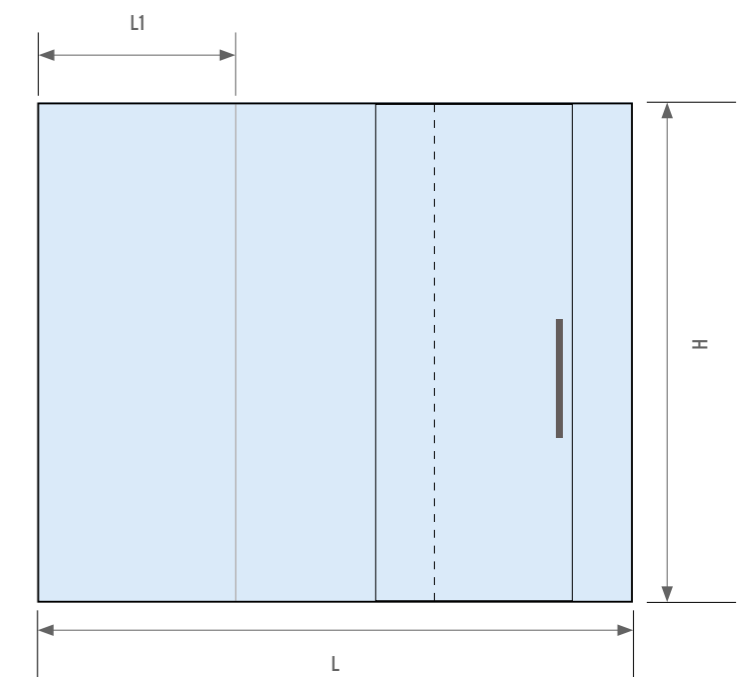

Garofoli Group glass sheets can also be used to make “all-glass” mixed systems consisting of fixed full-height glass walls and 1TV doors (sliding or swing), suitable for dividing work areas or for creating spaces that are acoustically insulated but visually open. Full-height glass sheets are separated only by a small transparent silicone seal. This type of assembly allows the creation of all-glass corners that don’t require any structural frame.



Porta tuttovetro 1TV con cerniere pivotanti nere, porta tuttovetro 1TV scorrevole.
Pareti fisse in vetro con profili di bloccaggio superiore e inferiore neri.

1TV all-glass door with black pivoting hinges, 1TV all-glass sliding door.
Fixed glass walls with black upper and lower locking strips.

PARETE DIVISORIA ORIENTABILE SWIVEL PARTITION WALL



Porta collezione Bisystem modello Biglass con vetri Marmo Nero Marquina.
Parete divisoria orientabile in Rovere Nero Profondo.

Bisystem collection door, Biglass model, with Black Marquina Marble glass.
Dark Black Oak swivel partition wall.

Parete divisoria aperta
Open partition wall

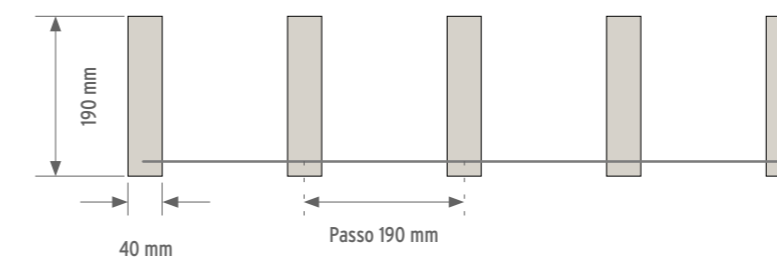

Nuovi elementi divisori in legno Garofoli fissati a bilico a soffitto e a pavimento, abbinabili alle Pareti vetrate Garofoli. Comodamente apribili o chiudibili attraverso una facile rotazione manuale, consentono la permeabilità della luce negli ambienti interni oppure la schermatura totale nella garanzia di una perfetta privacy visiva ed ambientale.

Parete divisoria chiusa
Closed open partition wall

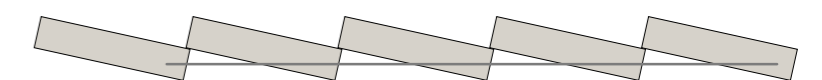

New Garofoli wood partitioning elements fastened to the ceiling and floor, which can be combined with Garofoli glass walls. Easily opened or closed by simple manual rotation, they allow light to enter indoor environments or total shielding to guarantee perfect visual and environmental privacy.



Parete Biglass con vetri Marmo Nero Marquina e parete fissa a vetro.
Parete divisoria orientabile in Rovere Nero Profondo.
Librerie componibili a due moduli in Rovere Nero Profondo.
Ante e piano cucina in Rovere Nero Profondo.

Biglass wall with Black Marquina Marble glass and fixed glass wall.
Dark Black Oak swivel partition wall.
Dark Black Oak two-piece modular bookcases.
Dark Black Oak doors and kitchen top.

Maniglia ATLANTA
ATLANTA Handle



Maniglia INFINITO
INFINITO Handle



Maniglia INFINITO PLACCA LUNGA
INFINITO PLACCA LUNGA Handle



Maniglia DUE
DUE Handle



Maniglia BOLT
BOLT Handle



Maniglia TIMELESS
TIMELESS Handle



NUOVO CATALOGO MANIGLIE PER PORTE E FINESTRE

DOORS AND WINDOWS HANDLES NEW CATALOGUE

Nuove maniglie abbinabili ai prodotti Garofoli:
Atlanta, Infinito, Infinito placca lunga, Due, Bolt e Timeless.

Finiture:

- _ Atlanta: bronzo, cromo lucido, cromo satinato, bianco, nero
- _ Infinito: cromo satinato, nero
- _ Infinito placca lunga: cromo satinato, nero
- _ Due: cromo satinato, nero
- _ Bolt: cromo lucido, cromo satinato, bianco, nero
- _ Timeless: cromo satinato, bianco, nero

La maniglia è un elemento cruciale del design d'interni, insieme alla porta è l'elemento di collegamento delle stanze in cui viviamo. Il modello Planum offre innovazioni che cambiano il modo di entrare in una stanza. Visivamente, tattilmente e acusticamente. Questo prodotto unisce meccanica di alta qualità e elettronica moderna, consentendo il bloccaggio e lo sblocco di una porta interna con il semplice tocco. Questa tecnologia offre ai suoi utenti un'esperienza speciale per quanto riguarda il contatto con le porte, eliminando il classico movimento di rotazione della maniglia.

New handles that can be matched with Garofoli products:
Atlanta, Infinito, Infinito placca lunga, Due, Bolt and Timeless.

Finishes:

- _ Atlanta: bronze, polished chrome, satin chrome, white, black
- _ Infinito: satin chrome, black
- _ Infinito long plate: satin chrome, black
- _ Due: satin chrome, black
- _ Bolt: polished chrome, satin chrome, white, black
- _ Timeless: satin chrome, white, black

The handle is a crucial element of interior design, together with the door is the connecting element of the rooms in which we live. The Planum model offers innovations that change the way of entering a room. Visually, tactilely, and acoustically. This product combines high quality mechanics and modern electronics, allowing the locking and unlocking of an interior door by touch. This technology offers its users a special experience concerning the contact with doors, eliminating the classic turning motion of the handle.



Consulta il nuovo catalogo Maniglie.
See the new Handles catalogue.



GAROFOLI
GROUP

AMBIENTI ROOM

- 40 BOISERIE LISCIA A TUTTA ALTEZZA
SMOOTH VERTICAL PANELLING
- 46 BOISERIE CON LISTELLI IN LAMINATO
LAMINATED SLATTED PANELLING
- 50 BOISERIE IN VETRO
GLASS PANELLING
- 58 CABINA UP
UP CABIN
- 62 COLLEZIONE MIRIA SMOOTH IN LEGNO
MIRIA SMOOTH COLLECTION IN WOOD
- 64 MIRIA BASSA CON TOP
LOW MIRIA WITH TOP
- 66 OPEN BOX INDUSTRIAL
OPEN BOX INDUSTRIAL
- 68 MENSOLA A PARETE "LINE"
WALL SHELF "LINE"
- 70 NUOVA LIBRERIA componibile
NEW MODULAR LIBRARY
- 72 PAVIMENTO "LIGHTWOOD"
"LIGHTWOOD" FLOOR
- 74 NUOVO CATALOGO PAVIMENTO SEAWOOD
NEW SEAWOOD FLOOR CATALOGUE
- 76 CUSTOM KITCHEN
CUSTOM KITCHEN
- 78 BOX DOCCIA
SHOWER CABIN
- 82 SPECCHIERE
MIRRORS
- 84 NUOVI TAVOLI IN LEGNO MASSICCIO
NEW SOLID WOOD TABLES
- 92 NUOVI TAVOLI E SEDUTE INDUSTRIAL
NEW INDUSTRIAL TABLES AND SEATING
- 94 SEDUTA "OAK"
"OAK" SITTING
- 96 COLLEZIONE "CERCHI DI LUCE"
"CERCHI DI LUCE" COLLECTION
- 98 COLLEZIONE "LED SQUARE LAMP"
"LED SQUARE LAMP" COLLECTION
- 100 LED WOOD LAMP
LED WOOD LAMP
- 102 LETTO BASE LEGNO E SOMMIER
WOOD BED BASE AND SOMMIER



Boiserie liscia a tutta altezza Laccato RAL 2012.
Full-height smooth panelling with RAL 2012 Lacquer.

AMBIENTI | ROOM

BOISERIE LISCIA A TUTTA ALTEZZA

SMOOTH VERTICAL PANELLING

GAROFOLI
GROUP

Le Boiserie Garofoli rispondono ai più alti standard qualitativi, caratterizzando ambienti coordinati di grande impatto visivo. La La Boiserie liscia a tutta altezza permette soluzioni progettuali ricercate, per ottenere una perfetta continuità visiva e stilistica. Finiture disponibili: laccati, laminati, legno e vetro.

Garofoli Panelling meets the highest quality standards, creating coordinated environments with a stunning visual impact. Full-height smooth panelling allows for sophisticated design solutions, to achieve perfect visual and stylistic continuity. Available finishes: lacquered, laminated, wood and glass.



Consulta il nuovo catalogo Boiserie.
See the Boiserie catalogue.



Boiserie a tutta altezza in Rovere Nero Profondo. Boiserie liscia quadrata Laccato RAL 7000.
Porta G-Like scorrevole, telaio nero. Parquet Garofoli Platinum in Rovere Nero.

Dark Black Oak full-height panelling. Smooth square panelling with RAL 7000 Lacquer.
Sliding G-Like door, black frame. Garofoli Platinum parquet in Black Oak.



Boiserie liscia a tutta altezza in laminato Malta Grigia.
Porta filomuro e armadiatura Miria in finitura Malta Grigia. Parquet Garofoli Platinum in Rovere Nero.

Vertical panelling in Grey Mortar Laminate.
Filomuro door and Miria closet with Grey Mortar finish. Garofoli Platinum Parquet in Black Oak.

AMBIENTI | ROOM

BOISERIE CON LISTELLI IN LAMINATO

LAMINATED SLATTED PANELLING



Boiserie a listelli e boiserie liscia in laminato Malta Sabbia. Porta Filomuro Malta Sabbia. Parquet Platinum e box con top in legno finitura Rovere Ice. Tavolo Light in Rovere Ice.
Slatted panelling and smooth panelling in Malta Sand laminate. Malta Sand Filomuro door. Platinum parquet and box with Ice Oak finish wooden top. Ice Oak Light table.



Consulta il nuovo catalogo Boiserie.
See the Boiserie catalogue.



Boiserie a listelli e boiserie liscia in laminato Malta Sabbia. Porta Filomuro Malta Sabbia. Parquet Platinum e box con top in legno finitura Rovere Ice. Tavolo Light in Rovere Ice.

Slatted panelling and smooth panelling in Malta Sand laminate. Malta Sand Filomuro door. Platinum parquet and box with Ice Oak finish wooden top. Ice Oak Light table.

BOISERIE IN VETRO GLASS PANNELLING



Porta collezione Bisystem modello Vert, vetri trasparenti, profili in alluminio neri, maniglia Playa nera.
Parquet Platinum Rovere Nero Profondo.
Rivestimento parete in vetro Marmo Nero Marquina.
Bisystem collection door, Vert model, transparent glass, black aluminium profiles, black Playa handle.
Dark Black Oak Platinum parquet.
Black Marquina Marble glass wall covering.

Nero Marquina

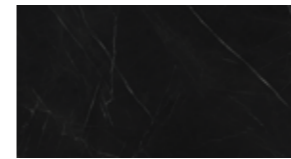

Borghini Grey



Ice

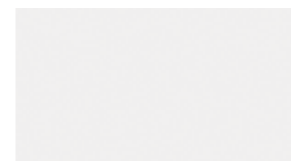

Cielo

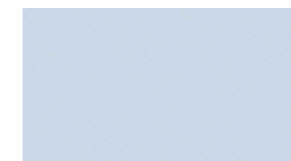

Madreperla

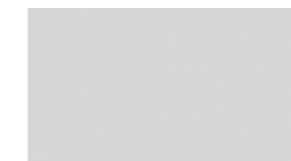

Grey



Nebbia



Corda

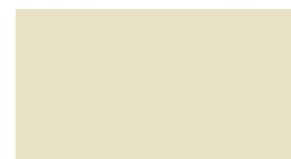

Cammello

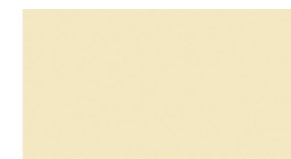

Cioccolato



Nero

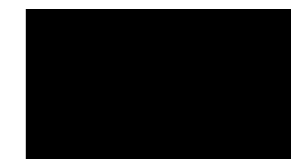

Corteccia



Argilla



Brasil



Fumo

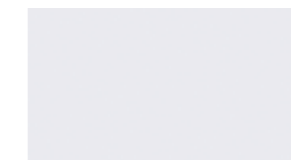

Specchio



Madras coprente

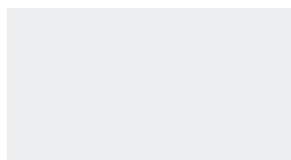

La boiserie verticale Garofoli può essere anche in vetro.
Novità nella novità: i nuovi vetri effetto marmo in bianco e in nero che aggiungono un tocco di lussuosità agli ambienti.

Garofoli vertical panelling can also be made of glass.
Another new development: the new black and white marble-effect glass that adds a touch of luxury to rooms.



Consulta il nuovo catalogo Boiserie.
See the Boiserie catalogue.



Porta collezione G-Like modello Blade in vetro Marmo Borghini Grey, profili in alluminio neri, maniglia Timeless nera.
Parquet Platinum Rovere Laccato Bianco a poro aperto.
Rivestimento parete in vetro Vetro Marmo Borghini Grey.

G-Like collection door, Blade model, Borghini Grey Marble glass, black aluminium profiles, black Timeless handle.
Open-pore White lacquered oak Platinum parquet.
Borghini Grey Marble glass glass wall covering.



Box Plus Rovere Ice con top in vetro Marmo Nero Marquina.
Rivestimento parete in vetro Marmo Nero Marquina.
Parquet Platinum Rovere Ice.

Ice Oak Box Plus with Black Marquina Marble glass top.
Black Marquina Marble glass wall covering.
Ice Oak Platinum parquet.

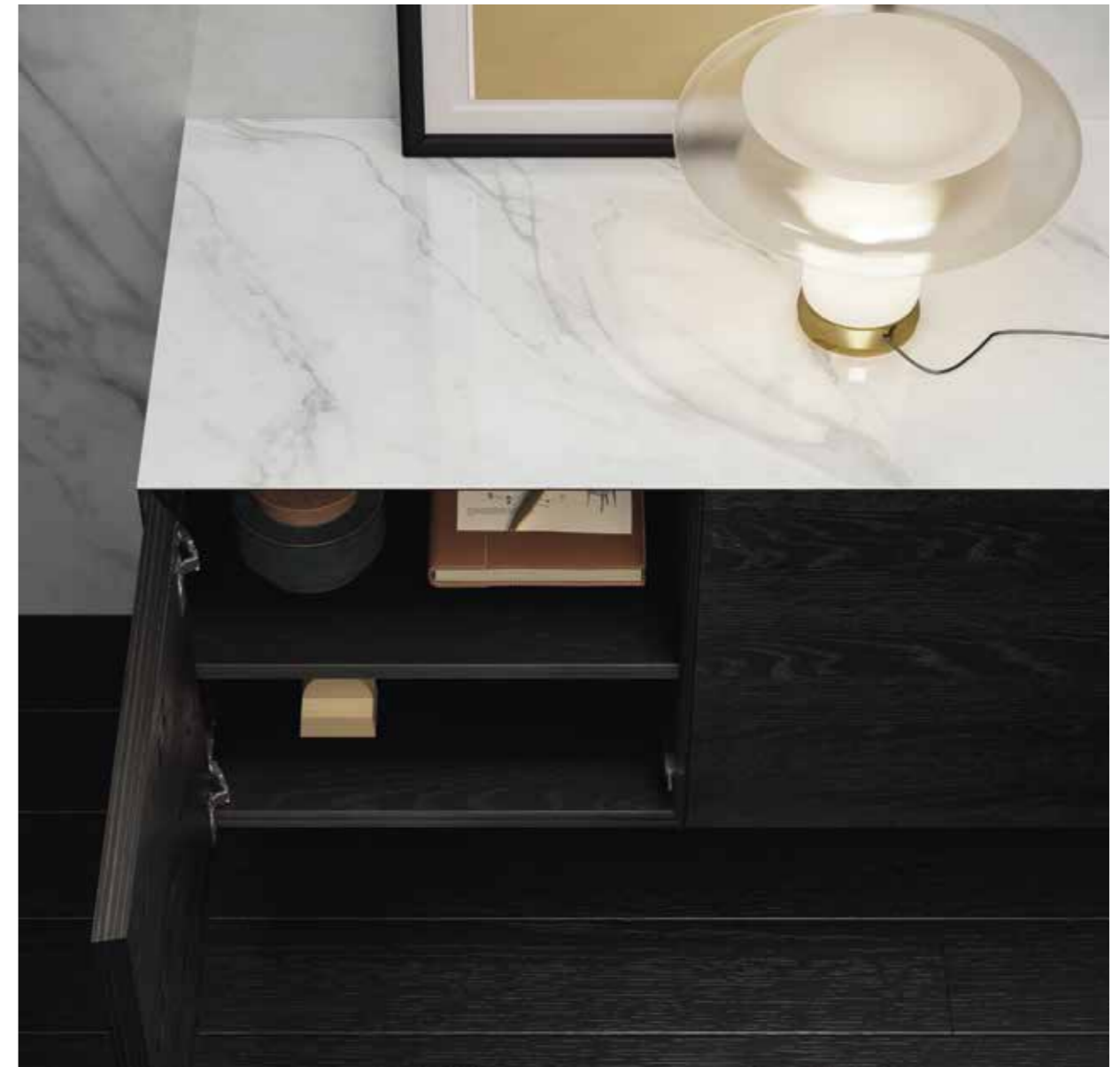

Box in Rovere Nero Profondo con top in vetro Marmo Borghini Grey, parquet Platinum Rovere Nero Profondo, porta Biglass modello Horizon.

Dark Black Oak box with Borghini Grey Marble glass top, Dark Black Oak Platinum parquet, Biglass door, Horizon model.

AMBIENTI | ROOM
CABINA UP
 UP CABIN



Boiserie a tutta altezza, ripiani e cassetti, finitura laccato RAL 7024, parquet Platinum Rovere Nero Profondo.

Full-height panelling, shelves and drawers, RAL 7024 lacquer finish, Dark Black Oak Platinum parquet.



Nuova cabina armadio con elementi in laminato o laccati per infinite possibilità di organizzazione degli spazi:

- ripiani orizzontali e inclinati;
- cassettiere;
- portamaglioni
- aste porta-abiti in acciaio;
- boiserie coordinata.

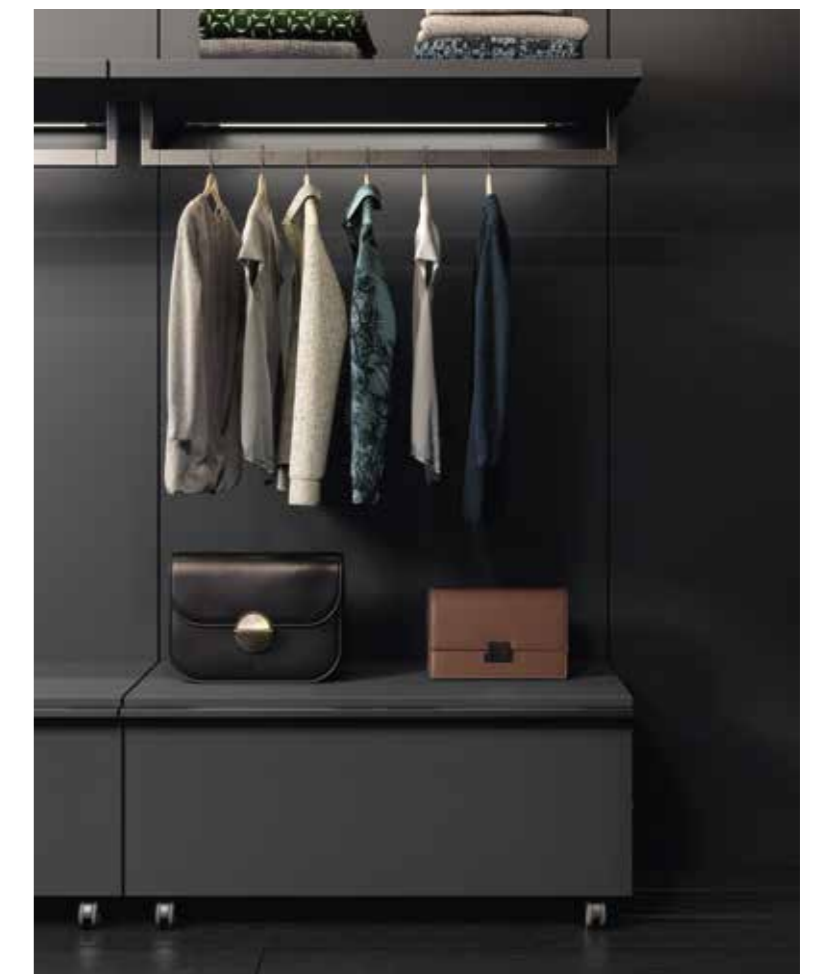

New cabinet with laminate or lacquered elements for infinite space organisation possibilities:

- horizontal and inclined shelves
- drawers
- sweater racks
- steel clothing racks
- coordinated panelling



Boiserie a tutta altezza, ripiani e cassetti, finitura laccato RAL 7024, parquet Platinum Rovere Nero Profondo.

Full-height panelling, shelves and drawers, RAL 7024 lacquer finish, Dark Black Oak Platinum parquet.

AMBIENTI | ROOM

COLLEZIONE MIRIA SMOOTH IN LEGNO MIRIA SMOOTH COLLECTION IN WOOD



Ante Miria Smooth modello Boise in Rovere Nero Profondo
Dark Black Oak Miria Smooth doors, Boise model



La Collezione Miria si arricchisce della nuova incisione nell'anta Smooth in legno: questo dettaglio consente di creare pareti-armadio in continuità visiva con la Boiserie Quadrata Garofoli

The Miria Collection is enriched with the new engraving in the Smooth wooden door: this detail allows you to create walls and closets in visual continuity with the Garofoli Quadrata panelling.

Miria Smooth modello Boise in Rovere Nero Profondo.
Dark Black Oak Miria Smooth, Boise model.



AMBIENTI | ROOM

MIRIA BASSA CON TOP LOW MIRIA WITH TOP

GIDEA

Ante Miria, mensola e Boiserie a tutta altezza e parquet Platinum Rovere Pietra.
Miria doors, shelf and full-height panelling and Stone Oak Platinum parquet.

Le ante Miria possono essere adatte anche per costruire box a terra chiusi, mantenendo lo stesso telaio Miria e altezza dell'anta minima. Contattare l'Ufficio Ambienti Garofoli per info sulle diverse possibilità di composizione.

Miria doors can also be employed to build closed low cabinets, using the same Miria frame and minimum door height. Contact Garofoli's Environments Office for information on the various composition possibilities.

AMBIENTI | ROOM

OPEN BOX INDUSTRIAL

OPEN BOX INDUSTRIAL

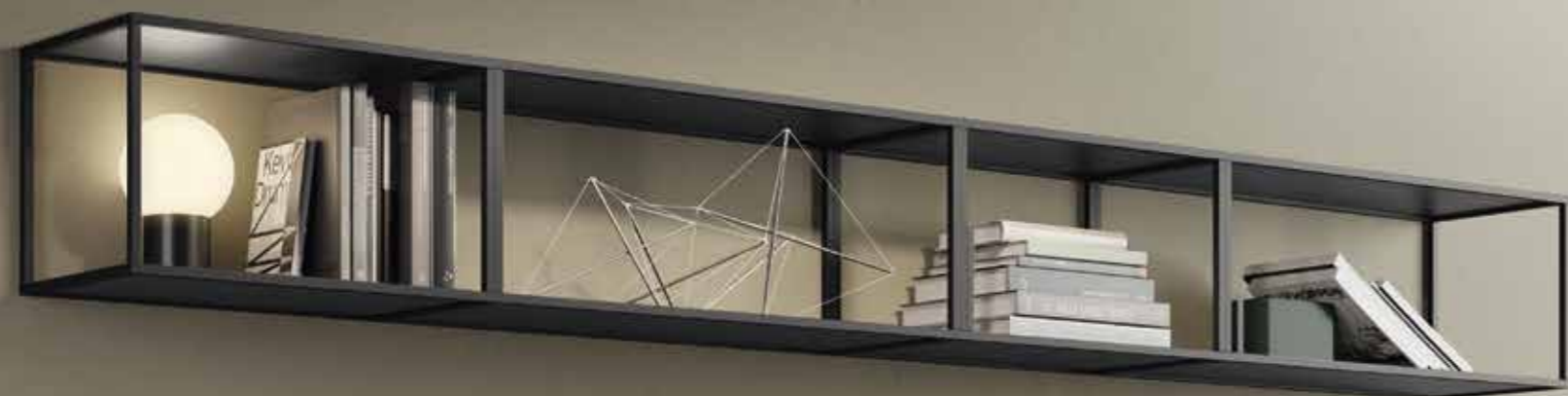

Open box Industrial con piani in Rovere Nero Profondo.
Sgabello in legno massiccio, parquet e battiscopa Rovere Nero Profondo.

Industrial open box with Dark Black Oak surfaces.
Dark Black Oak solid wood stool, parquet and skirting boards.

Box con mensole in legno
Box with wood shelves

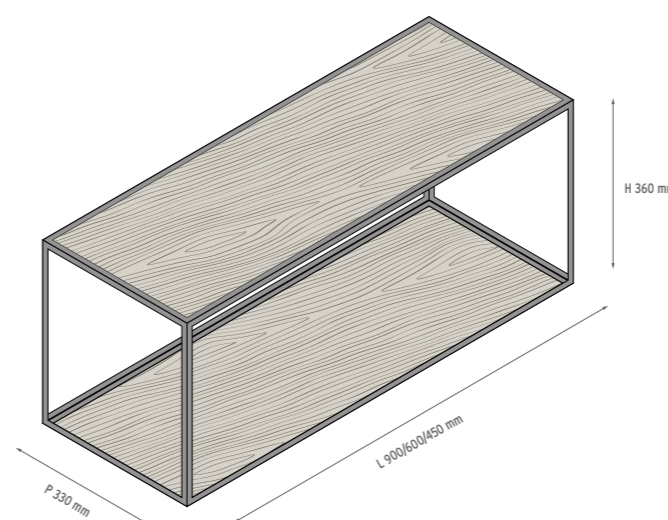

Le superfici orizzontali (piani di appoggio) possono essere in rovere impiallacciato (qualsiasi finitura del Catalogo Boiserie) oppure in vetro.

Box con mensole in vetro
Box with glass shelves

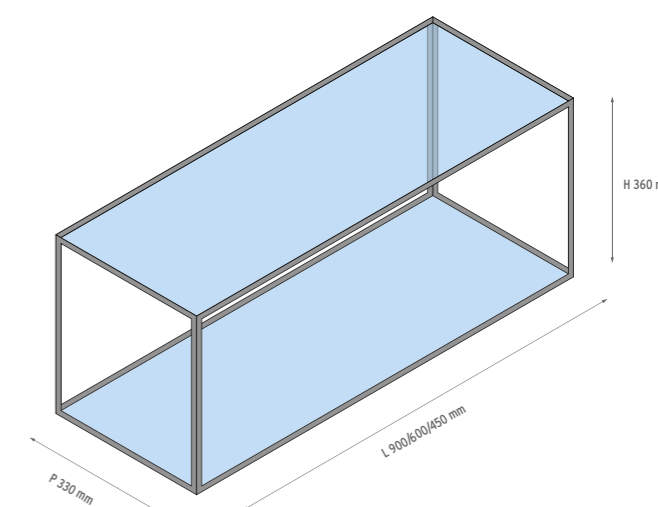

The horizontal surfaces (tops) can be in veneered oak (any finish of the Panelling Catalogue) or glass.

AMBIENTI | ROOM

MENSOLA A PARETE "LINE" WALL SHELF "LINE"

GAROFOLI
GROUP



Mensole a parete Line in Rovere Ice.
Parquet, battiscopa e boiserie in Rovere Ice.

Ice Oak Line wall shelves.
Ice Oak parquet, skirting boards and panelling.



Mensola vista dal basso
Bottom view shelf

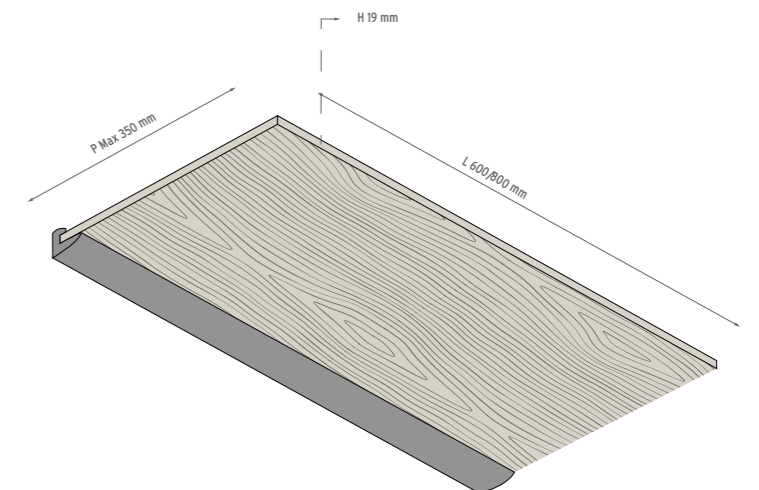

I ripiani possono essere in tutti i Rovere delle Collezioni
Garofoli.

The shelves can be in any Oak of the Garofoli Collections.



Composizione con boiserie Garofoli e libreria componibile in legno Rovere Ice.

Composition with Garofoli panelling and modular bookcase in Ice Oak.

AMBIENTI | ROOM

NUOVA LIBRERIA COMPONIBILE NEW MODULAR LIBRARY

GAROFOLI
GROUP

Modulo quadrato - Misure h 38,5 x L38,5 xP 38,5
Square module - Measurement h 38,5 x L38,5 xP 38,5



La nuova libreria componibile del catalogo Ambienti Garofoli è il risultato dell'abbinabilità di due moduli facilmente integrabili: uno quadrato e uno rettangolare. Grazie alla modularità degli elementi coordinati Garofoli, in tutte le finiture Rovere del listino, è possibile abbinare i nuovi box qui mostrati alle boiserie, alle mensole e alle ante Miria Plus. Infinite combinazioni che permettono di realizzare progetti di grande eleganza.

Modulo rettangolare - Misure h 77 x L38,5 xP 38,5
Rectangular module - Measurements h 77 x L38,5 xP 38,5



The new modular bookcase in the Ambienti Garofoli catalogue is the result of the combination of two modules that can be easily integrated: one square and one rectangular. Thanks to the modularity of the Garofoli coordinated elements – available in all the Oak finishes of the price list – it is possible to combine the new boxes shown here with the panelling, the shelves and the Miria Plus doors. Infinite combinations that allow you to design projects of great elegance.

AMBIENTI | ROOM

PAVIMENTO “LIGHTWOOD” FLOOR “LIGHTWOOD”



Rovere verniciato o finitura ad olio
Painted oak or oil finish

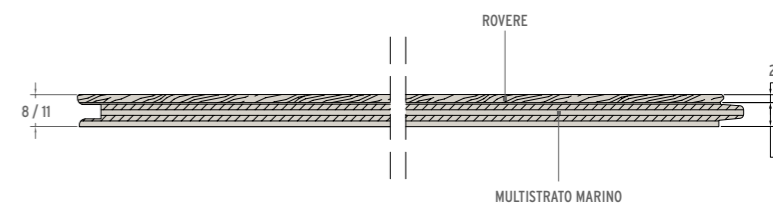

Pavimento in legno disponibile in 8 mm o 11 mm di spessore, ottimo per rivestire pavimentazioni preesistenti. Ideale per l'installazione su pareti verticali e soffitti.

Wooden floor available in 8 mm or 11 mm thick, great for covering pre-existing floors. Ideal for installation on vertical walls and ceilings.



AMBIENTI | ROOM

NUOVO CATALOGO PAVIMENTO SEAWOOD NEW SEAWOOD FLOOR CATALOGUE

GAROFOLI
GROUP



PAVIMENTO IN LEGNO
WOOD FLOOR

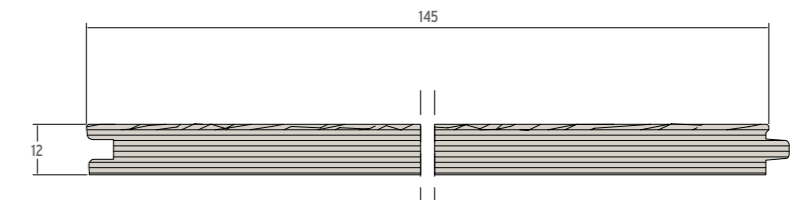

Pavimento in legno interamente costruito in multistrato marino, altamente resistente all'acqua e all'umidità.

Wooden floor made entirely of marine plywood, highly resistant to water and moisture.



Consulta il sito web Garofoli.
See the Garofoli web site.



Nuova cucina Custom Kitchen con ante finitura Malta Grigia. Sportelli, box, porta Filomuro Biplan e parquet Platinum in Rovere Seta. Isola e top, finitura Gres Porcellanato Bianco Lucido.

New Custom Kitchen with Grey Malta finish doors. Doors, cabinets, Filomuro Biplan door and Platinum parquet in Silk Oak. Island and top, Polished White porcelain stoneware tile finish.

AMBIENTI | ROOM

CUSTOM KITCHEN CUSTOM KITCHEN

GAROFOLI
GROUP

Una possibilità unica di coordinare perfettamente le superfici della cucina con la boiserie, il parquet, le porte e tanti altri elementi coordinati della proposta Garofoli Group.

A unique opportunity to perfectly coordinate the kitchen surfaces with the panelling, parquet, doors and many other coordinated elements from the Garofoli Group.



Consulta il catalogo Custom Kitchen.
See the Custom Kitchen catalogue.



AMBIENTI | ROOM
BOX DOCCIA
SHOWER CABIN

GAROFOLI
 GROUP



Box doccia KIT D - Muro / Muro.
 Shower cabin KIT D - Wall / Wall.

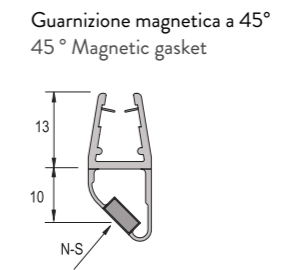
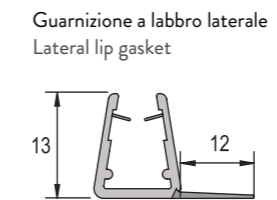

KIT 1 - MURO / MURO
 KIT 1 - WALL / WALL

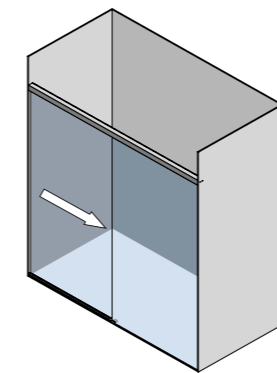

KIT 2 - MURO / VETRO
 KIT 2 - WALL / GLASS

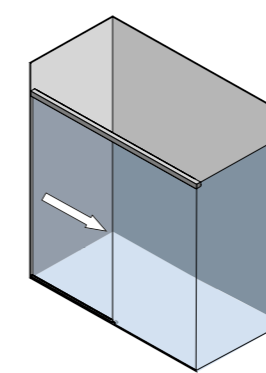

KIT 3 - VETRO / VETRO
 KIT 3 - GLASS / GLASS

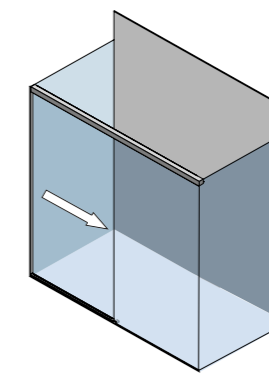

KIT 4 - ANGOLO 90°
 KIT 4 - 90° ANGLE

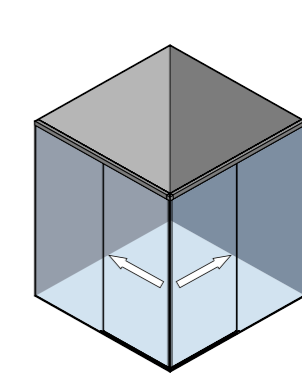

KIT A - MURO / ARIA
 KIT A - WALL / AIR

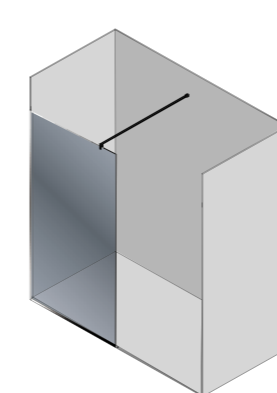

KIT B - MURO / MURO
 KIT B - WALL / WALL

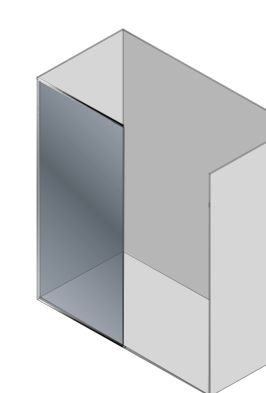

KIT C - MURO / MURO
 KIT C - WALL / WALL

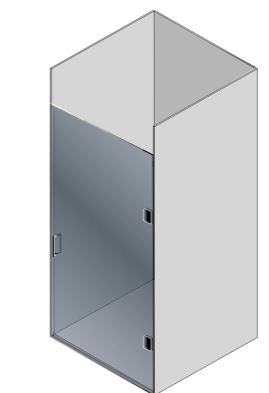

KIT D - MURO / MURO
 KIT D - WALL / WALL

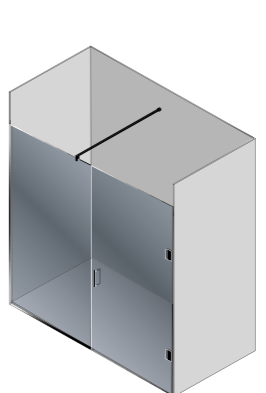

KIT E - VETRO / VETRO
 KIT E - GLASS / GLASS





Box doccia KIT A - Muro / Aria.
Shower cabin KIT A - Wall / Air.



Box doccia KIT 2 - Muro / Vetro.
Shower cabin KIT 2 - Wall / Glass.

AMBIENTI | ROOM
SPECCHIERE
MIRRORS

GAROFOLI
 GROUP



Mensole, box e boiserie Rovere Nero Profondo. Specchio rettangolare 120x70.
 Dark Black Oak shelves, boxes and panelling. Rectangular mirror 120x70.

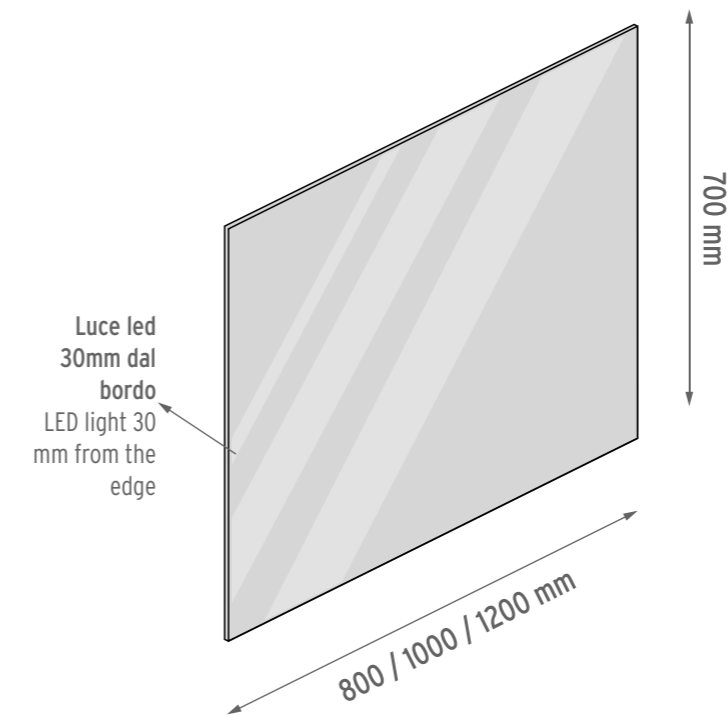

SPECCHI RETTANGOLARI

- _ 70x80 - 70x100 - 70x120 cm
- _ limiti minimi x specchiere fuori misura 300x300 mm
- _ limiti massimi x specchiere fuori misura 1200 mm (versione orizzontale o verticale)
- _ sistema di supporto alluminio rettangolare
- _ led posizionato a 30 mm dal bordo a tutto specchio

SPECCHI CIRCOLARI

- _ diametro 70 cm
- _ limiti minimi x specchiere fuori misura 300 mm
- _ limiti massimi x specchiere fuori misura 1200 mm
- _ sistema di supporto alluminio esagonale
- _ led posizionato a 30 mm dal bordo a tutto specchio

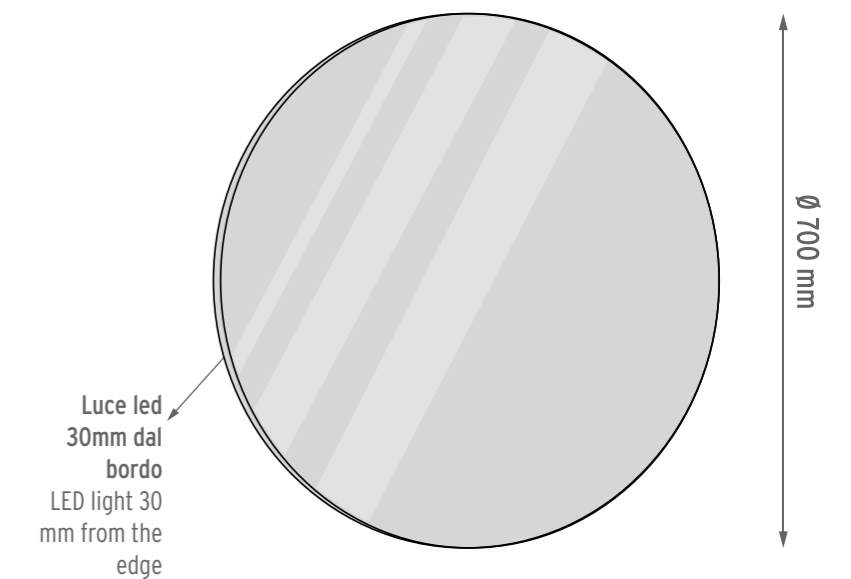

RECTANGULAR MIRRORS

- _ 70x80 - 70x100 - 70x120 cm
- _ minimum for non-standard mirrors 300x300 mm
- _ maximum for non-standard mirrors 1200 mm (horizontal or vertical version)
- _ rectangular aluminium support system
- _ LED positioned at 30 mm from all edges of the mirror

CIRCULAR MIRRORS

- _ diameter 70 cm
- _ minimum limits for non-standard mirrors 300 mm
- _ maximum limits for non-standard mirrors 1200 mm
- _ hexagonal aluminium support system
- _ LED positioned at 30 mm from all edges of the mirror



Composizione con boiserie Garofoli e tavolo LIGHT in legno Rovere Ice.
Composition with Garofoli panelling and wood table LIGHT in Ice Oak.

AMBIENTI | ROOM

NUOVI TAVOLI IN LEGNO MASSICCIO

NEW TABLES IN SOLID WOOD

GAROFOLI
GROUP

PIANO CON BORDATURA A 45° E 90°
TOP WITH 45° AND 90° EDGES

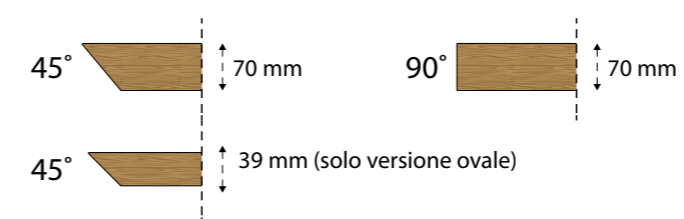

BASAMENTO
BASE

light: legno e vetro / vetro vetro
round e cross: grigio graphite RAL 9016*
*finitura a richiesta: nero opaco RAL 9010

light: wood and glass
round and cross: grey graphite RAL 9016*
*finish on request: matt black RAL 9010

ABBINAMENTI
COMBINATIONS



TAVOLI "LIGHT"
TABLE "LIGHT"



TAVOLI "ELLIPSE"
TABLE "ELLIPSE"



TAVOLI "ROUND"
TABLE "ROUND"

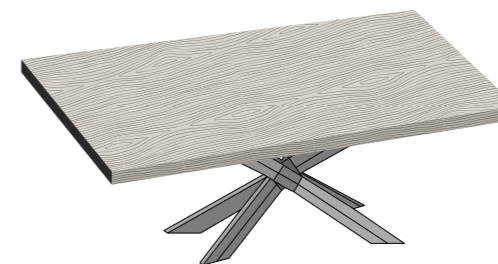

TAVOLI "CROSS"
TABLE "CROSS"

Nuovi tavoli disponibili nella gamma di prodotti del catalogo Ambienti Garofoli. Ordinabili in tutte le finiture rovere della Garofoli.

New tables available in the Ambienti Garofoli catalogue. Available in all the Garofoli oak finishes.



Tavolo Cross in Rovere Ice coordinato con box e parquet.
Collezione Cerchi di Luce mod. L 400 - L 800

Ice Oak Cross table coordinated with box and parquet.
Cerchi di Luce collection model L 400 - L 800



Tavolo Round, parquet e battiscopa in Rovere Creta.
Round table, parquet and skirting boards in Crete Oak.



Tavolo Round e boiserie in Rovere Seta.
Round table and panelling Silk Oak.



Tavolo Light e parquet in Rovere Ice.
Light table and Ice Oak parquet.



Tavolo Ellipse, parquet e battiscopa in Rovere Naturale.
Mensola Line in Rovere Naturale.
Collezione Cerchi di Luce mod. L 400 - L 800.
Ellipse table, parquet and skirting boards in Natural Oak.
Natural Oak Line shelf.
Cerchi di Luce collection model L 400 - L 800.



Tavolo, sgabelli e mensole Industrial coordinati con parquet e boiserie Rovere Seta. Collezione Led Square Lamp.

Industrial table, stools and shelves coordinated with parquet and Silk Oak panelling. LED Square Lamp collection.

AMBIENTI | ROOM

NUOVI TAVOLI E SEDUTE INDUSTRIAL

NEW INDUSTRIAL TABLES AND SEATING

GAROFOLI
GROUP



Piano in Parquet Rovere: Brandy, Caldo (Senza Nodi), Castagno, Cipria, Creta, Cuoio Scuro, Decapè, Grigio, Grigio Antico, Ice, Naturale, Nero Profondo, Pietra, Sbiancato, Seta, Tabacco, Teak, Terra, Wengè
Struttura: tubolare quadro 20x20 mm, in metallo verniciato

Oak Parquet top: Brandy, Warm (without knots), Chestnut, Powder, Crete, Dark Leather, Decapè, Grey, Antique Grey, Ice, Natural, Deep Black, Stone, Bleached, Silk, Tabacco, Teak, Earth, Wengè
frame: 20x20 mm square tubular, painted metal.



TAVOLI "INDUSTRIAL ALTO"
TABLE "INDUSTRIAL ALTO"



SEDUTA "INDUSTRIAL"
SITTING "INDUSTRIAL"

Nuovi tavoli disponibili nella gamma di prodotti del catalogo Ambienti Garofoli. Ordinabili in tutte le finiture Rovere della Garofoli.

Altezze disponibili per il tavolo 96 cm (come in foto) o 75 cm.
Altezze disponibili per lo sgabello 73 cm (come in foto) o 52 cm.

New tables available in the Ambienti Garofoli catalogue. Available in all the Garofoli Oak finishes.
Table heights: 96 cm (as pictured) or 75 cm.
Stool heights: 73 cm (as pictured) or 52 cm.



AMBIENTI | ROOM
SEDUTA “OAK”
“OAK” SITTING



Sgabelli in legno massiccio Rovere Ice, parquet Rovere Laccato Bianco, boiserie Laccata Bianca a doghe.
Ice Oak solid wood stools, White Lacquered Oak parquet, White Lacquered slatted panelling.

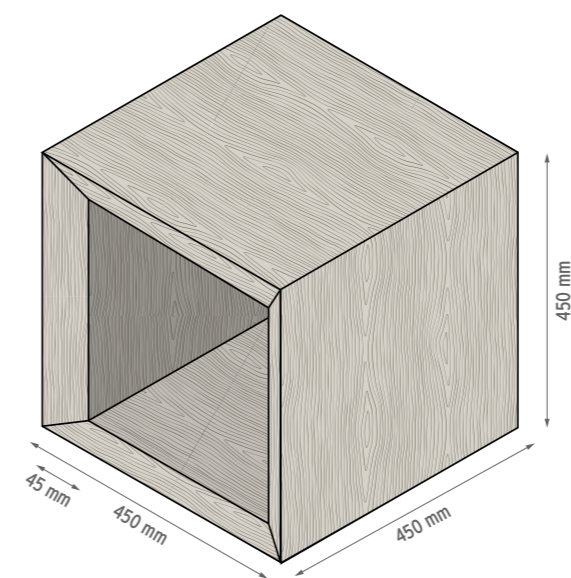

AMBIENTI | ROOM

COLLEZIONE “CERCHI DI LUCE” “CERCHI DI LUCE” COLLECTION



MOD. L 100 - L 400



MOD. L 0 - L 0



MOD. H 1800



MOD. L 400 - L 800



MOD. L 800 - L 800





Lampada Collezione "Led Square Lamp". Boiserie a tutta altezza e Porta Filomuro Bilato, finitura Malta Grigia

"Led Square Lamp" Collection. Full-height panelling and Bilato Filomuro door, Grey Malta finish

AMBIENTI | ROOM

COLLEZIONE "LED SQUARE LAMP"

"LED SQUARE LAMP" COLLECTION

GAROFOLI
GROUP

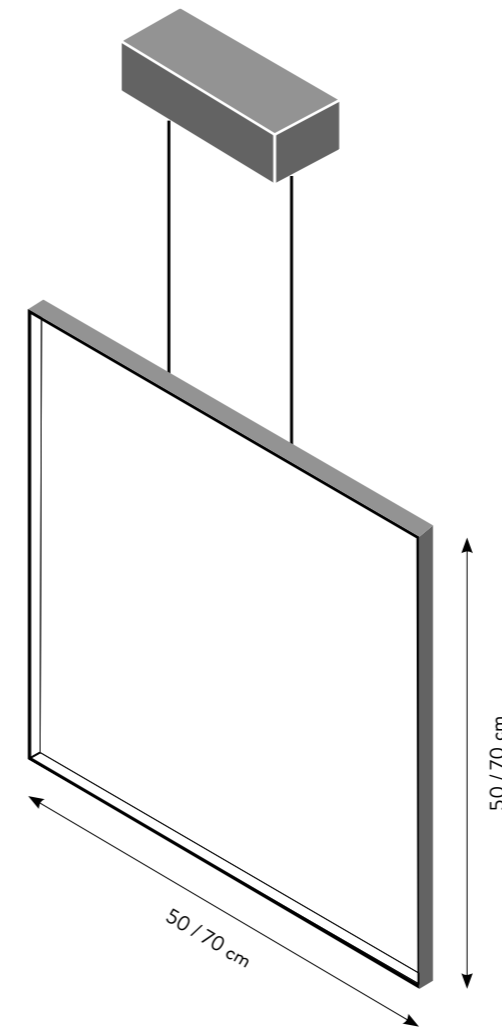



Led Wood Lamp due moduli 40x40x25 cm
LED Wood Lamp, two modules 40x40x25 cm

AMBIENTI | ROOM

LED WOOD LAMP LED WOOD LAMP

GAROFOLI
GROUP

Modulo 40x40x25 cm
Module 40x40x25 cm



Visto da sotto
seen from below

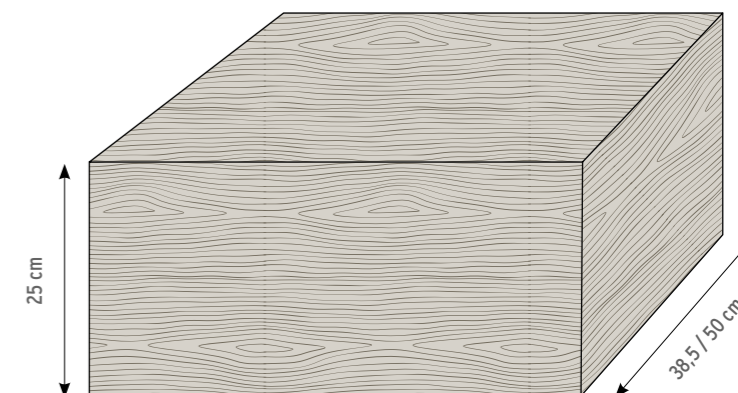
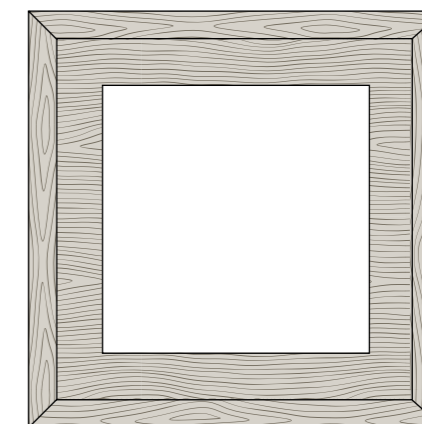

Nuove plafoniere disponibili nella gamma di prodotti del catalogo Ambienti Garofoli. Ordinabili in tutte le finiture rovere della Garofoli.

New ceiling lights available in the Ambienti Garofoli catalogue. Available in all the Garofoli oak finishes.

AMBIENTI | ROOM

LETTO BASE LEGNO E SOMMIER

WOOD BED BASE AND SOMMIER



Letto Sommier con base legno, boiserie liscia orizzontale e box con anta a ribalta, finitura Rovere Ice.
Sommier bed with wooden base, horizontal smooth panelling and box with tilting door, Ice Oak finish.

Letto matrimoniale in Rovere
Double bed in Oak



Letto singolo in Rovere
Single bed in Oak



Letto Sommier matrimoniale
Sommier double bed



Sommier letto singolo
Sommier single bed



Nuovo letto in legno Garofoli con contenitore, realizzabile in tutte le finiture Rovere. Letto Sommier in ecopelle.

New Garofoli wood bed with container, available in all Oak finishes. Sommier bed in faux leather.

CERTIFICAZIONI | CERTIFICATIONS | CERTIFICAZIONES | CERTIFICACIONES | ZERTIFIZIERUNGEN | СЕРТИФИКАТЫ

Il Gruppo Garofoli ha sempre mirato alla qualità, promuovendo lo sviluppo sostenibile delle proprie attività e perseguendo una decisa politica ambientale. Una filosofia che ha portato al raggiungimento di importanti traguardi.

› 2001_ **ISO 9001** Sistema di gestione della qualità.

› 2009_ **ISO 14001** Sistema di gestione ambientale.

› 2009_ **COC/PEFC™** Program for endorsement of forest certification schemes, lo schema più diffuso e famoso al mondo per la gestione sostenibile delle foreste.

› 2010_ **OHSAS 18001** Sistema di gestione per la sicurezza e salute sui luoghi di lavoro.

› 2015_ **FSC_Forest Stewardship Council: Forest For All Forever: www.ic.fsc.org**

The **Garofoli Group** has always aimed at quality, promoting the sustainable development of its business activities and pursuing a strong environmental policy. A philosophy which has resulted in the attainment of important goals.

› 2001_ **ISO 9001** Quality management system.

› 2009_ **ISO 14001** Environmental management system.

› 2009_ **COC/PEFC™** Certification program for endorsement of forest certification schemes, the most widespread and renown scheme in the world for sustainable forest management.

› 2010_ **OHSAS 18001** Certification management system for occupational health and safety.

› 2015_ **FSC_Forest Stewardship Council: Forest For All Forever: www.ic.fsc.org**

Le **Groupe Garofoli** a toujours recherche la qualité, promouvant le developpement durable de ses activités et poursuivant une politique environnementale claire. Une philosophie qui a permis d'atteindre des objectifs majeurs.

› 2001_ **ISO 9001** Système de management de la qualité.

› 2009_ **ISO 14001** Système de management environnemental.

› 2009_ **COC/PEFC™** Program for endorsement of forest certification schemes, le système de certification le plus repandu et connu au monde pour la gestion durable des forets.

› 2010_ **OHSAS 18001** Système de gestion de la santé et de la sécurité au travail.

› 2015_ **FSC_Forest Stewardship Council: Forest For All Forever: www.ic.fsc.org**

El **Grupo Garofoli** persigue desde siempre la calidad, promoviendo el desarrollo sostenible de sus actividades y adoptando una específica política ecológica. Esta filosofía lo ha llevado a alcanzar importantes objetivos.

› 2001_ **ISO 9001** Sistema de gestión de la calidad.

› 2009_ **ISO 14001** Sistema de gestión medioambiental.

› 2009_ **COC/PEFC™** Program for endorsement of forest certification schemes. El esquema más difuso y famoso en todo el mundo por lo que concierne la gestión forestal sostenible.

› 2010_ **OHSAS 18001** sistema de gestión para la seguridad y salud laboral.

› 2015_ **FSC_Forest Stewardship Council: Forest For All Forever: www.ic.fsc.org**

Die **Gruppe Garofoli** setzt seit jeher auf Qualität, und in diesem Sinn auf eine nachhaltige, umweltverträgliche Firmenpolitik. Eine Unternehmensphilosophie; die sich unter allen Aspekten als zielführend und gewinnbringend erwiesen hat.

› 2001_ **ISO 9001** Qualitätsmanagementsystem.

› 2009_ **ISO 14001** Umweltmanagementsystem.

› 2009_ **COC/PEFC™** Program for endorsement of forest certification schemes. Das bekannteste und weltweit am meisten genutzte Konzept zur nachhaltigen Bewirtschaftung und Nutzung der Wälder.

› 2010_ **OHSAS 18001** Arbeitsschutz management system.

› 2015_ **FSC_Forest Stewardship Council: Forest For All Forever: www.ic.fsc.org**

Группа **Garofoli** всегда заботилась о качестве, способствовала экологически рациональному развитию своего бизнеса, придерживаясь твердой стратегии, связанной с защитой окружающей среды. такой подход позволил группе добиться важных результатов.

› 2001_ **ISO 9001** Система менеджмента качества.

› 2009_ **ISO 14001** Система экологического менеджмента.

› 2009_ **COC/PEFC™** Program for endorsement of forest certification schemes. Самая широко распространенная и известная программа в мире по экологически рациональному управлению лесными богатствами.

› 2010_ **OHSAS 18001** Система менеджмента техники безопасности и охраны здоровья на рабочем месте.

› 2015_ **FSC_Forest Stewardship Council: Forest For All Forever: www.ic.fsc.org**



Tutti i modelli possono subire in qualsiasi momento senza preavviso qualche lieve variazione nelle sezioni, nella struttura, nel disegno e nel colore; pertanto, qualora a nostro insindacabile giudizio resti immutata l'estetica complessiva e la solidità della porta, il cliente non potrà recedere dal contratto, né avrà diritto a sconti o abbuoni particolari. Tutte le essenze, i colori e le trasparenze dei vetri, particolari dei modelli e modelli delle porte illustrati nel presente catalogo sono da ritenersi indicativi e possono subire modifiche.

All models may be subject to slight variations in section, structure, design and colour at any time, without advance notice; therefore, if the overall appearance and solidity of the door remains unchanged in our unquestionable judgement, the client may not withdraw from the contract, nor be entitled to special discounts or rebates. All of the woods, coloured and transparent glass, door models and details of the models illustrated in this catalogue are merely indicative and may be subject to modification.

Tous les modeles peuvent subir, a tout moment et sans preavis, de legeres variations dans les sections, la structure, le design et la couleur; par consequent, lorsque l'esthetique globale et la solidite de la porte restent telles quelles selon notre jugement sans appel, le client ne pourra annuler le contrat ni aura le droit a reductions ou remises particulieres. Tous les essences, teintes et transparences des vitres, details des modeles des portes illustres dans ce catalogue sont a considerer comme indicatifs et peuvent etre sujets a modifications.

Todos los modelos pueden sufrir, en cualquier momento y sin previo aviso, leves modificaciones en las secciones, la estructura, el motivo o el color; mientras estas modificaciones, a juicio inapelable del fabricante, no alteren la estética general ni la solidez de la puerta, el cliente no podrá rescindir el contrato ni tendrá derecho a descuentos o bonificaciones de ningún tipo. Todas las maderas, los colores y las transparencias de los cristales, el diseño de las puertas y los respectivos detalles ilustrados en este catálogo deben considerarse indicativos y pueden sufrir modificaciones.

Der hersteller behält sich das recht vor, an allen modellen jederzeit ohne vorankündigung geringfügige mass-, struktur-, design-und farbänderungen vorzunehmen; sofern nach dem unanfechtbaren ermessens des herstellers dadurch weder die gesamtoptik noch die robustheit der tür beeinträchtigt werden, hat der kunde kein recht auf stornierung des auftrags und/oder preisnachlässe und/ oder gutschriften jeglicher art. Alle hölzer, die farben und die transparenzen des glases, details der modelle und modelle der in diesem katalog abgebildeten türen haben reinen beispielcharakter, abweichungen sind daher möglich.

Все модели могут претерпеть в любой момент и без предупреждения небольшие изменения сечений, конструкции, дизайна и цвета. Поэтому, если по нашему неоспоримому мнению общий вид и прочность двери не меняются, клиент не имеет права расторгнуть контракт, а также требовать скидки или специальную компенсацию. Все породы древесины, цвета, степень прозрачности стекла, детали моделей и модели дверей, представленные в этом каталоге, должны считаться ориентировочными и могут претерпеть изменения.



new generation doors

Garofoli SpA
Via Recanatese, 37
60022 Castelfidardo
AN Italia
tel. +39 071 727171
fax +39 071 780380
info@garofoli.com
www.garofoli.com

